

Befestigung FI-10-ZM-P

Ref. C28117N00

Ref. arch 42244

- Queraufhängung am Stab oder am Seil
- Kleine Abmessungen

ZWECK DES PRODUKTS

- zum Aufhängen von LED-Leuchten

INSTALLATION

- am Stab oder Kabel, mit einem Druckbolzen
- mit einer Druckschraube am Stab



TECHNISCHE ZEICHNUNG

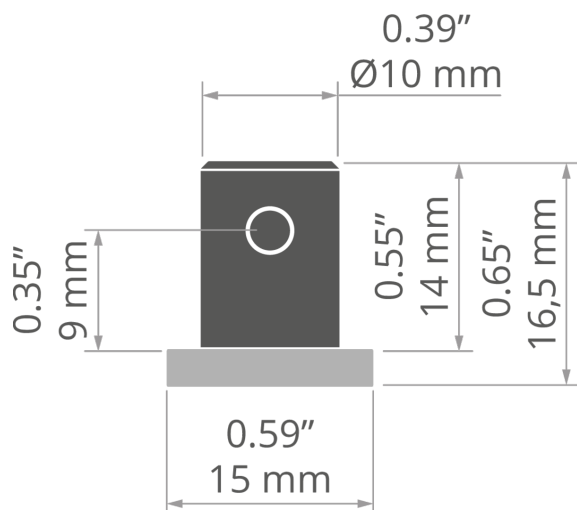

TECHNISCHE SPEZIFIKATIONEN

Material	rostfreier Stahl
Farbe	■ silbern
Breite	15 mm

Höhe	16.5 mm
Tragfähigkeit	30 kg

Befestigung FI-10-ZM-P

Ref. C28117N00

Ref. arch 42244

VERWANDTE PROFILE > ARCHITEKTONISCH



3035
A18039
Ref. arch 18039



3035-O
A08441
Ref. arch B8441



4050
A18050
Ref. arch 18050



4050-W
A18051
Ref. arch 18051



GIZA
A05556
Ref. arch B5556



GIZA-DUO-LL
A02162
Ref. arch C2162



GIZA-LL
A00758
Ref. arch C0758

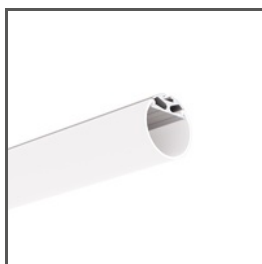

JAZ
A08547
Ref. arch B8547

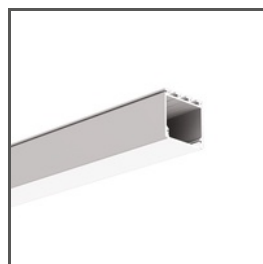

LIPOD
A05554
Ref. arch B5554



OPK-4
A00370
Ref. arch C0370

VERWANDTE PROFILE > FÜR HAUPTBELEUCHTUNG

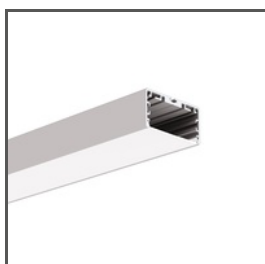

LIPOD-50
A02609
Ref. arch C2609

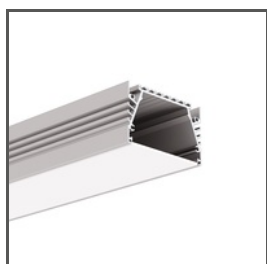

SEPOD
A06593
Ref. arch B6593

VERWANDTE PROFILE > MINIMALISTISCH



PIKO-ZM
A01168
Ref. arch C1168

VERWANDTE PROFILE > UNIVERSAL

Befestigung FI-10-ZM-P

Ref. C28117N00

Ref. arch 42244



OLEK
A08505
Ref. arch B8505



PDS-ZM-PLUS
A02056
Ref. arch C2056

VERWANDTE SYSTEME > FÜR ALLGEMEINBELEUCHTUNG



3035-KOZE
A08441+A18056
Ref. arch 18056+B8441



PK-4
A18044+A00370
Ref. arch 18044+C0370

PASSENDES ZUBEHÖR > ANDERE > SEILE UND STÄBE

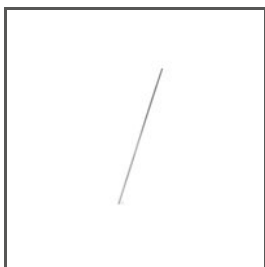

STAB
FI-3 1m
42501

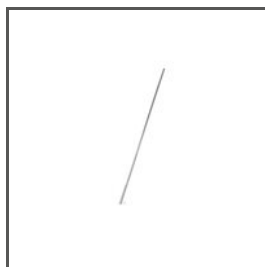

STAB
100 PUSZ 1 m
42518

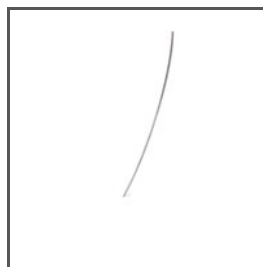

STAB
FI-3 53 cm
C24528N00
Ref. arch 1528



STAB
FI-3-ALU
C28196A01, C28196A07
Ref. arch 42526, 42527, 42528, 42529