

Profil REGULOR

Ref. A18068

Ref. arch B468+43



- Einstellung des Beleuchtungswinkels
- Breite Palette an Zubehör

ZWECK DES PRODUKTS

- Hauptbeleuchtung und dekorative Beleuchtung

INSTALLATION

- an der Oberfläche, aufgehängt oder in Einlässen, unter Verwendung von speziellem Zubehör, entsprechend ausgewählten Schrauben, doppelseitigem Klebeband oder Montageklebern
- einfache Montage und Demontage durch Ein- und Ausrasten

ZUSÄTZLICHE INFORMATION

- dank des einstellbaren LED-Einsatzes kann das Profil so konfiguriert werden, dass Beleuchtungswinkel von 10, 30, 45, 60 oder 90 Grad erzielt werden
- Standardlängen von Kluś Profilen und Abdeckungen: 1000mm (Toleranz $\pm 1,5$ mm) und 2005mm / 3010mm (Toleranz +5mm); für ausgewählte Abdeckungen 6050mm, 10050mm (Toleranz +5mm)
- Bei der Auswahl einer nicht standardmäßigen Länge der Profile / Abdeckungen sollten Sie den Zuschnittservice bei KLUŚ dazuwählen

TECHNISCHE ZEICHNUNG

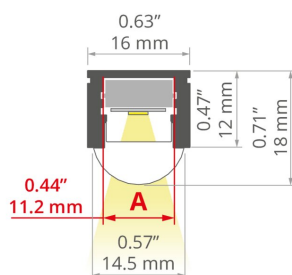

TECHNISCHE SPEZIFIKATIONEN

Material	Aluminium
Farbe	silbern eloxiert
Mögliche IP der Leuchte	20, 67
Breite	16 mm
Höhe	12 mm
LED-Klebebreite A	11.2 mm
Anzahl LED-Streifen A (8 mm breit)	1
Einstellung der Beleuchtungswinkelbreite von	10
Einstellung der Beleuchtungswinkelbreite bis zu	90
Gebäudetyp	Außenbeleuchtung
Einrichtungszone	Stadtmöbel, Grüne Architektur, Fassadenbeleuchtung, Treppen und Handläufe, wejścia i bramy
Einfache Montage und Demontage durch Ein- und Ausrasten	ja
Abdeckung zugeschnitten auf die Profillänge	ja
Kabelführung durch die Endkappe	ja
Kabelführung von unten	ja

Länge	Ref
1000 mm	A18068A_1 B468+43ANODA_1
2005 mm	A18068A_2 B468+43ANODA_2
3010 mm	A18068A_3 B468+43ANODA_3

Profil REGULOR



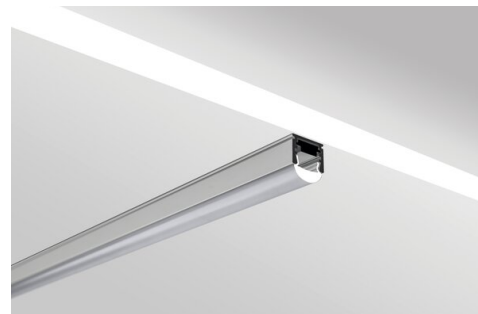

Ref. A18068

Ref. arch B468+43



BEISPIELPROJEKTE



PASSENDENES ZUBEHÖR > ABDECKUNGEN

NAME	MATERIAL	LICHTDURCHLÄSSIGKEIT	FARBE	REF.
S	 PC	73 %	 transparente	B17202T 00220
S-SATYNA	 PC	67 %	 transparente	B17202S 17111

PASSENDENES ZUBEHÖR > ENDKAPPEN

NAME	MATERIAL	FARBE	REF.
REGULOR	 PP	 grau	C20116C02 00310
REGULOR-OTW	 PP	 grau	C20116C02TW 00313

PASSENDENES ZUBEHÖR > RELATED LED



8K-WP-K-1275-12V

_biąd

Ref. arch 8K-WP-K-1275-12V

PASSENDENES ZUBEHÖR > RELATED LED > HÖHE EFFIZIENZ

Profil REGULOR

Ref. A18068

Ref. arch B468+43

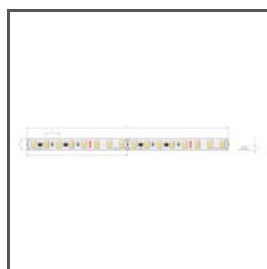

K-HE-0480-HD-24V
K-HEHD-0480-24
Ref. arch K-HE-0480-HD-24V

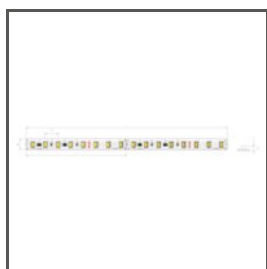

K-HE-0960-HD-24V
K-HEHD-0960-24
Ref. arch K-HE-0960-HD-24V

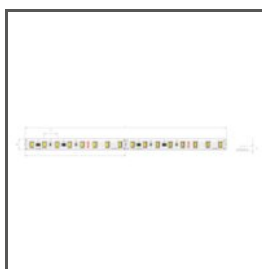

K-HE-1440-HD-24V
K-HEHD-1440-24
Ref. arch K-HE-1440-HD-24V

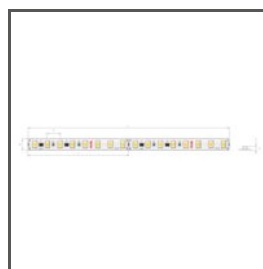

K-HE-1920-HD-24V
K-HEHD-1920-24
Ref. arch K-HE-1920-HD-24V

PASSENDEN ZUBEHÖR > ANDERE > AUFHÄNGUNGS- UND BEFESTIGUNGSSÄTZE



AUSLEGER
K5G-AB
C28270N00
Ref. arch 42051



BEFESTIGUNG SET
W1
C28203N00
Ref. arch 42602

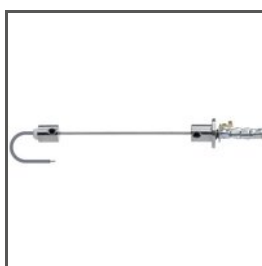

BEFESTIGUNG SET
W2
C28204N00
Ref. arch 42603



BEFESTIGUNG SET
M3
C28182N00
Ref. arch 42303



BEFESTIGUNG SET
M4
C28180N00
Ref. arch 42301



BEFESTIGUNG SET
M5
C28181N00
Ref. arch 42302



BEFESTIGUNG SET
W6
C28205N00
Ref. arch 42604

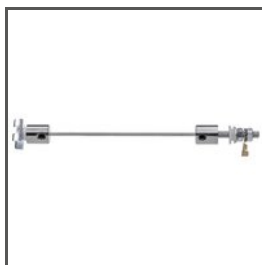

BEFESTIGUNG SET
W9
C28207N00
Ref. arch 42607

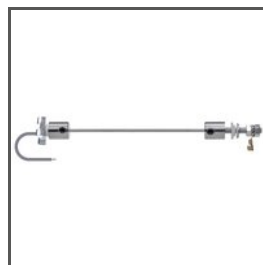

BEFESTIGUNG SET
W10
C28208N00
Ref. arch 42608



BEFESTIGUNG SET
RG-1
C28230P00, C28230P01,
C28230L10, C28230L07
Ref. arch 42647NI, 42647GSS,
42647L9010, 42647L9005

PASSENDEN ZUBEHÖR > ANDERE > BEFESTIGUNGSCLIPS



BEFESTIGUNGSCLIP
PDS-STN
C24190N00
Ref. arch 24190



BEFESTIGUNGSCLIP
REG-PD-UV
C28055C02
Ref. arch 24270



BEFESTIGUNGSCLIP
PL-PDM
C24041 C02
Ref. arch 24041



BEFESTIGUNGSCLIP
PDS
C24189C02, C24223C10
Ref. arch 24189, 24223



BEFESTIGUNGSCLIP
PDS-STN-90G
C24370N00, C24370L07,
C24370L10
Ref. arch 24370, 24370RAL9005,
24370RAL9010

Profil REGULOR

Ref. A18068

Ref. arch B468+43



BEFESTIGUNGSCLIP

PDS-STN-90D

C24367N00, C24367L07,
C24367L10

Ref. arch 24367, 24367RAL9005,
24367RAL9010



BEFESTIGUNGSCLIP

PDS-STN-ALFA

C28060N00

Ref. arch 24426



NEU

BEFESTIGUNGSCLIP

PDS-STN-45D

C24456N00

Ref. arch 24456



NEU

BEFESTIGUNGSCLIP

PDS-STN-60D

C24457N00

Ref. arch 24457

PASSENDES ZUBEHÖR > ANDERE > SONSTIGE



KABELVERSCHRAUBUNG

6x1,2

C24517C07

Ref. arch 00802

PASSENDES ZUBEHÖR > ANDERE > STANDARD-BEFESTIGUNGEN UND -KÖPFE FÜR PROFILE



KOPF

ST

C28114N00

Ref. arch 42216



KOPF

BZP

C28113N00

Ref. arch 42213

PASSENDES ZUBEHÖR > ANDERE > STROMFÜHRENDE BEFESTIGUNGEN UND KÖPFE FÜR PROFILE

Profil REGULOR

Ref. A18068

Ref. arch B468+43



KOPF

ZO

C28115N00
Ref. arch 42217



BEFESTIGUNG

PUSZ-PRET-MR

C28166N00, C28166L10,
C28166L07
Ref. arch 42281, 42281L9010,
42281L9005



BEFESTIGUNG

PUSZ-LIN-MR

C28163N00, C28163L10,
C28163L07
Ref. arch 42278, 42278L9010,
42278L9005



BEFESTIGUNG

FI-8-LIN-MR

C28172N00, C28172L10,
C28172L07
Ref. arch 42287, 42287L9010,
42287L9005