

Profil STEP

Ref. A18042

Ref. arch 18042

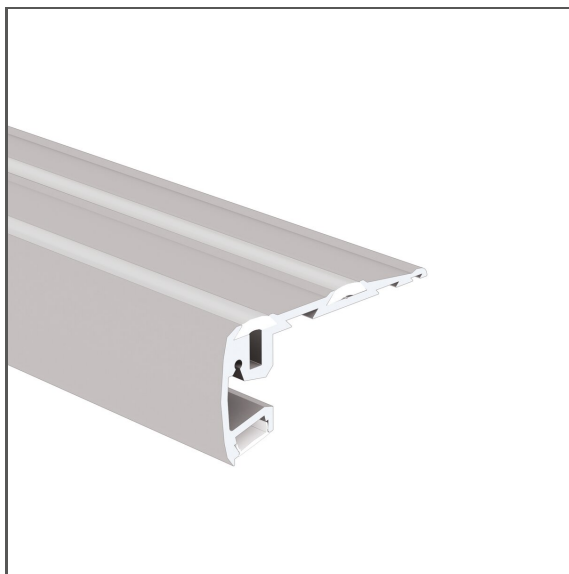

- Zur Montage an Treppenstufen
- Rutschfeste Elemente
- Zwei Beleuchtungsvarianten
- Hohe mechanische Beständigkeit

ZWECK DES PRODUKTS

- Warnbeleuchtung und Rutschschutz auf der Treppe

INSTALLATION

- an der Treppe, mit entsprechend ausgewählten Schrauben

ZUSÄTZLICHE INFORMATION

- Standardlängen von KLUŚ Profilen und Abdeckungen: 1000mm (Toleranz ± 1,5mm) und 2005mm / 3010mm (Toleranz +5mm); für ausgewählte Abdeckungen 6050mm, 10050mm (Toleranz +5mm)
- Bei der Auswahl einer nicht standardmäßigen Länge der Profile / Abdeckungen sollten Sie den Zuschnittservice bei KLUŚ dazuwählen

TECHNISCHE ZEICHNUNG

1:2

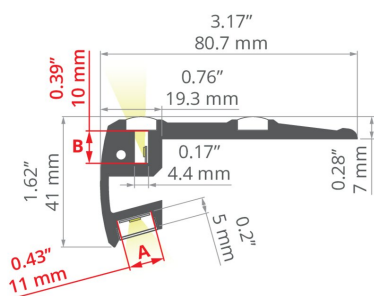

TECHNISCHE SPEZIFIKATIONEN

Material	Aluminium
Mögliche IP der Leuchte	20, 67
Breite	80.7 mm
Höhe	40 mm
LED-Klebebreite A	11 mm
LED-Klebebreite B	10 mm
Anzahl LED-Streifen A (8 mm breit)	1
Gebäudetyp	Kulturelle/Unterhaltungseinrichtung, Kommerzielles Gebäude, HoReCa-Anlage, Handelsgebäude
Einrichtungszone	Treppen und Handläufe
Abdeckung zugeschnitten auf die Profillänge	ja
Kabelführung von unten	ja

Farbe	Länge	Ref
■ silbern eloxiert	1000 mm	A18042A_1 18042ANODA_1
	2005 mm	A18042A_2 18042ANODA_2
	3010 mm	A18042A_3 18042ANODA_3
■ schwarz eloxiert	1000 mm	A18042A07_1 18042K7_1
	2005 mm	A18042A07_2 18042K7_2
	3010 mm	A18042A07_3 18042K7_3

Profil STEP

Ref. A18042

Ref. arch 18042



BEISPIELPROJEKTE



PASSENDES ZUBEHÖR > ABDECKUNGEN

NAME	MATERIAL	LICHTDURCHLÄSSIGKEIT	FARBE	REF.
60	PC	64 %	<input type="checkbox"/> milchige	17075
LIGER	PC	70 %	<input type="checkbox"/> milchige	B17037M 17037
		32 %	<input checked="" type="checkbox"/> schwarz	B17037C 17040
KA-COM	PVC	70 %	<input type="checkbox"/> milchige	B17179M 17179
		93 %	<input checked="" type="checkbox"/> transparente	B17179T 17180
HS	PC	73 %	<input type="checkbox"/> milchige	B17208M 1369
		94 %	<input checked="" type="checkbox"/> transparente	B17208T 1370
KA-PRO	PC	67 %	<input type="checkbox"/> milchige	B17064M 17064
		94 %	<input checked="" type="checkbox"/> transparente	B17064T 17065
KA	PC	63 %	<input type="checkbox"/> milchige	B17035M 17035
		91 %	<input checked="" type="checkbox"/> transparente	B17035T 17036

PASSENDEN ZUBEHÖR > ENDKAPPEN

NAME	MATERIAL	FARBE	REF.
STEP-P		■ grau	C28006C02 24113
		■ schwarz	C28006C07 24126
STEP-L		■ grau	C28007C02 24114
		■ schwarz	C28007C07 24125
STEP-90		■ grau	C24025C02 24025

PASSENDEN ZUBEHÖR > RELATED LED

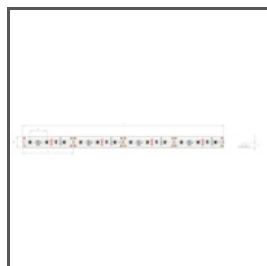

K-1210-12V
K-1210-12
Ref. arch K-1210-12V



K-1275-12V
K-1275-12
Ref. arch K-1275-12V



WP-K-1220-12V
KWP-1220-12
Ref. arch WP-K-1220-12V

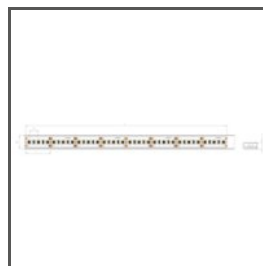

WP-K-1275-12V
KWP-1275-12
Ref. arch WP-K-1275-12V



WP-K-1220-IP65-12V
_bład
Ref. arch WP-K-1220-IP65-12V

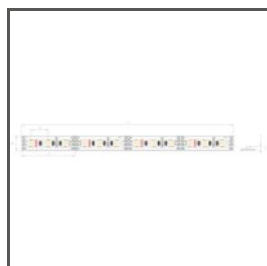

K-1275-RGB-12V
K-RGB-1275-12
Ref. arch K-1275-RGB-12V

PASSENDEN ZUBEHÖR > RELATED LED > CRI 95+



WP-K-CR-1210-24V
KWP-CR-1210-24
Ref. arch WP-K-CR-1210-24V



WP-K-CR-1220-24V
KWP-CR-1220-24
Ref. arch WP-K-CR-1220-24V



WP-K-CR-1275-24V
KWP-CR-1275-24
Ref. arch WP-K-CR-1275-24V

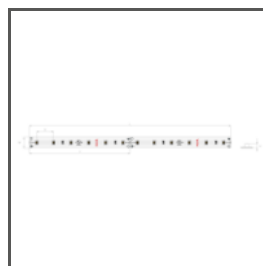

K-CR-1210-24V
K-CR-1210-24
Ref. arch K-CR-1210-24V

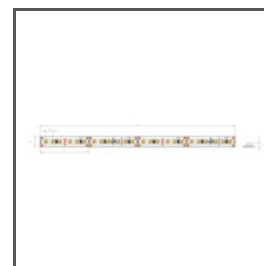

K-CR-1220-24V
K-CR-1220-24
Ref. arch K-CR-1220-24V

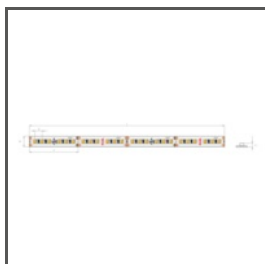

K-CR-1275-24V

K-CR-1275-24

Ref. arch K-CR-1275-24V

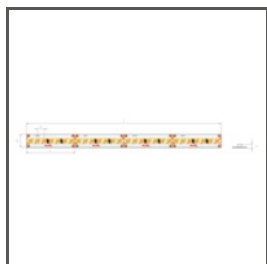

K-CR-1820-HD-24V

K-CRHD-1820-24

Ref. arch K-CR-1820-HD-24V

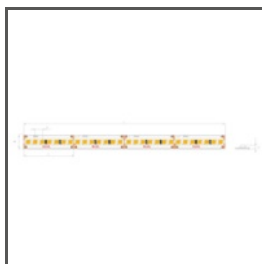

K-CR-1910-HD-24V

K-CRHD-1910-24

Ref. arch K-CR-1910-HD-24V

PASSENDEN ZUBEHÖR > RELATED LED > HÖHE EFFIZIENZ

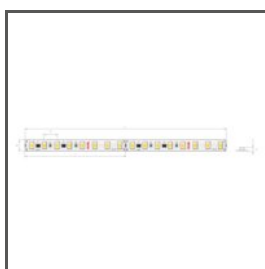

K-HE-0480-HD-24V

K-HEHD-0480-24

Ref. arch K-HE-0480-HD-24V

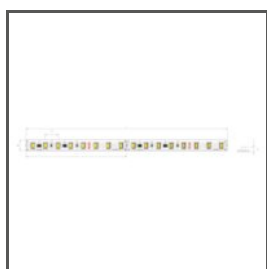

K-HE-0960-HD-24V

K-HEHD-0960-24

Ref. arch K-HE-0960-HD-24V

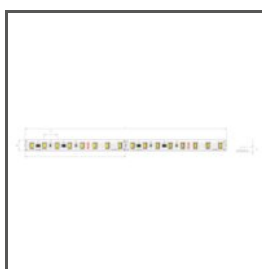

K-HE-1440-HD-24V

K-HEHD-1440-24

Ref. arch K-HE-1440-HD-24V

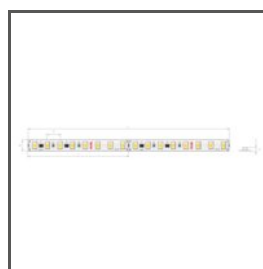

K-HE-1920-HD-24V

K-HEHD-1920-24

Ref. arch K-HE-1920-HD-24V

PASSENDEN ZUBEHÖR > RELATED LED > MONOWEISS



WP-K-1910-HD-IP65-24V

KWP-GHD-1910-24

Ref. arch WP-K-1910HDIP6524V

PASSENDEN ZUBEHÖR > RELATED LED > RGB / RGB-W / RGB-CTT



K-1530-RGB+W-24V

K-RGBW-1530-24

Ref. arch K-1530-RGB+W-24V



K-1920-120-RGB-24V

K-RGB-1920-120-24

Ref. arch K-1920-120-RGB-24V



WP-K-1920-120-RGB-24V

KWP-1920-120-RGB-24

Ref. arch WP-K-1920-120-RGB-24V

PASSENDEN ZUBEHÖR > RELATED LED > SEITLICH LEUCHTEND

Profil STEP

Ref. A18042

Ref. arch 18042



K-SE-1210-8-24V
K-SE-1210-24-8
Ref. arch K-SE-1210-8-24V



WP-K-SE-1210-8-24V
KWP-SE-1210-24-8
Ref. arch WP-K-SE-1210-8-24V

PASSENDEN ZUBEHÖR > ANDERE > SILIKONSCHNÜRE



RUTSCHFESTE SCHNUR

14
C24537C00
Ref. arch 17001

PASSENDEN ZUBEHÖR > ANDERE > SONSTIGE



KABELVERSCHRAUBUNG

6,4x3
C42264C07
Ref. arch 42264

PASSENDEN ZUBEHÖR > ANDERE > SONSTIGES ZUBEHÖR



GERÄT
C28063
Ref. arch 00023