



■ Features

- Constant voltage PWM style output
- Emergency lighting application is available according to IEC61347-2-13
- Built-in active PFC function and class II design
- No load power consumption <0.5W/ standby power consumption <0.5W(DA/DA2-type)
- Fully encapsulated with IP67 level
- Function options: 3 in 1 dimming (dim-to-off); DALI/DALI-2
- Minimum dimming level 0.2% for DALI type
- Typical lifetime>50000 hours and 5 years warranty

■ Applications

- LED strip lighting
- Indoor LED lighting
- LED decorative lighting
- LED architecture lighting
- Industrial lighting
- Type “HL” for use in class I, division 2 hazardous (classified) location.

■ Description

PWM-120 series is a 120W AC/DC LED driver featuring the constant voltage mode with PWM style output, which is able to maintain the color temperature and the brightness homogeneity when driving all kinds of LED strips. PWM-120 operates from 90~305VAC and offers models with different rated voltage ranging between 12V and 48V. Thanks to the high efficiency up to 90.5%, with the fanless design, the entire series is able to operate for -40°C ~ +90°C case temperature under free air convection. The entire series is rated with IP67 ingress protection level and is suitable to work for dry, damp or wet locations. PWM-120 is equipped with dimming function that varies the duty cycle of the output, providing great flexibility for LED strips applications.

■ Model Encoding

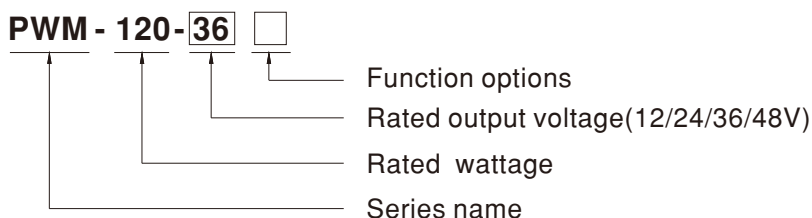

| Type | IP Level | Function | Note |
|-------|----------|--|----------|
| Blank | IP67 | 3 in 1 dimming function (0~10Vdc, 10V PWM signal and resistance) | In stock |
| DA | IP67 | DALI control technology.(for 12V/24V DA type only) | In stock |
| DA2 | IP67 | DALI-2 control technology.(for 12V/24V with DA2 Type only) | In stock |

SPECIFICATION

| MODEL | | PWM-120-12 □ | PWM-120-24 □ | PWM-120-36 □ | PWM-120-48 □ |
|---------------------|---|--|----------------|----------------|--------------|
| OUTPUT | DC VOLTAGE | 12V | 24V | 36V | 48V |
| | RATED CURRENT | 10A | 5A | 3.4A | 2.5A |
| | RATED POWER | 120W | 120W | 122.4W | 120W |
| | DIMMING RANGE | 0 ~ 100% | | | |
| | PWM FREQUENCY (Typ.) | 1.47kHz for Blank/DA-Type, 2.5kHz for DA2-Type | | | |
| | SETUP, RISE TIME ^{Note.2} _{Note.9} | 500ms, 80ms/ 230VAC or 115VAC | | | |
| HOLD UP TIME (Typ.) | 16ms/230VAC or 115VAC | | | | |
| INPUT | VOLTAGE RANGE ^{Note.3} | 90 ~ 305VAC 127 ~ 431VDC (Please refer to "STATIC CHARACTERISTIC" section) | | | |
| | FREQUENCY RANGE | 47 ~ 63Hz | | | |
| | POWER FACTOR (Typ.) | PF>0.97/115VAC, PF>0.96/230VAC, PF>0.93/277VAC @ full load (Please refer to "POWER FACTOR (PF) CHARACTERISTIC" section) | | | |
| | TOTAL HARMONIC DISTORTION | THD< 20%(@load≥60%/115VAC, 230VAC; @load≥75%/277VAC) (Please refer to "TOTAL HARMONIC DISTORTION" section) | | | |
| | EFFICIENCY (Typ.) | 88% | 90% | 90% | 90.5% |
| | AC CURRENT (Typ.) | 1.3A / 115VAC | 0.65A / 230VAC | 0.55A / 277VAC | |
| | INRUSH CURRENT (Typ.) | COLD START 60A(twidth=520μs measured at 50% Ipeak) at 230VAC; Per NEMA 410 | | | |
| | MAX. NO. of PSUs on 16A CIRCUIT BREAKER | 4 units (circuit breaker of type B) / 6 units (circuit breaker of type C) at 230VAC | | | |
| | LEAKAGE CURRENT | <0.25mA / 277VAC | | | |
| | NO LOAD/STANDBY POWER CONSUMPTION | No load power consumption<0.5w for blank-type;standby power consumption<0.5W for DA-type/DA2-type | | | |
| PROTECTION | OVERLOAD | 108 ~ 130% rated output power Hiccup mode, recovers automatically after fault condition is removed | | | |
| | SHORT CIRCUIT | 12V/24V hiccup mode and 36V/48V shut down mode(including DA-type/except for DA2-type) Hiccup mode,recovers automatically after fault condition is removed (only for DA2-type) | | | |
| | OVER VOLTAGE | 15 ~ 17V | 28 ~ 34V | 41 ~ 46V | 54 ~ 60V |
| | OVER TEMPERATURE | Shut down o/p voltage, re-power on to recover | | | |
| ENVIRONMENT | WORKING TEMP. | Tcase=-40 ~ +90°C (Please refer to " OUTPUT LOAD vs TEMPERATURE" section) | | | |
| | MAX. CASE TEMP. | Tcase=+90°C | | | |
| | WORKING HUMIDITY | 20 ~ 95% RH non-condensing | | | |
| | STORAGE TEMP., HUMIDITY | -40 ~ +80°C, 10 ~ 95% RH | | | |
| | TEMP. COEFFICIENT | ±0.03%/°C (0 ~ 45°C,except 0 ~ 40°C for 12V) | | | |
| VIBRATION | 10 ~ 500Hz, 5G 12min./1cycle, period for 72min. each along X, Y, Z axes | | | | |
| SAFETY & EMC | SAFETY STANDARDS ^{Note.5} | UL8750(type "HL")(except for 12DA type), CSA C22.2 No. 250.13-12; ENEC BS EN/EN61347-1, BS EN/EN61347-2-13, BS EN/EN62384 independent, IP67, BIS IS15885(for PWM-120-12,24 only), EAC TP TC 004,GB19510.1,GB19510.14 approved; Design refer to BS EN/EN60335-1; According to BS EN/EN61347 - 2 - 13 appendix J suitable for emergency installations | | | |
| | DALI STANDARDS | IEC62386-101, 102, 207,251 for DA/DA2-Type only, Device type 6(DT6) | | | |
| | WITHSTAND VOLTAGE | I/P-O/P:3.75KVAC; I/P-DA:1.5KVAC; O/P-DA:1.5KVAC | | | |
| | ISOLATION RESISTANCE | I/P-O/P:100M Ohms / 500VDC / 25°C / 70% RH | | | |
| | EMC EMISSION ^{Note.6} | Compliance to BS EN/EN55015, BS EN/EN61000-3-2 Class C (@load ≥ 60%) ; BS EN/EN61000-3-3,GB17743 and GB17625.1,EAC TP TC 020 | | | |
| EMC IMMUNITY | Compliance to BS EN/EN61000-4-2,3,4,5,6,8,11; BS EN/EN61547, light industry level (surge immunity Line-Line 2KV),EAC TP TC 020 | | | | |
| OTHERS | MTBF | 860.4K hrs min. Telcordia SR-332 (Bellcore) ; 228.7K hrs min. MIL-HDBK-217F (25°C) | | | |
| | DIMENSION | 191*63*37.5mm (L*W*H) | | | |
| | PACKING | 0.97Kg; 15pcs/15.6Kg/0.87CUFT | | | |
| NOTE | <p>1. All parameters NOT specially mentioned are measured at 230VAC input, rated current and 25°C of ambient temperature.</p> <p>2. De-rating may be needed under low input voltages. Please refer to "STATIC CHARACTERISTIC" sections for details.</p> <p>3. Length of set up time is measured at first cold start. Turning ON/OFF the driver may lead to increase of the set up time.</p> <p>4. The driver is considered as a component that will be operated in combination with final equipment. Since EMC performance will be affected by the complete installation, the final equipment manufacturers must re-qualify EMC Directive on the complete installation again.</p> <p>5. This series meets the typical life expectancy of >50,000 hours of operation when Tcase, particularly (Tc) point (or TMP, per DLC), is about 75°C or less.</p> <p>6. Please refer to the warranty statement on MEAN WELL's website at http://www.meanwell.com</p> <p>7. The ambient temperature derating of 3.5°C/1000m with fanless models and of 5°C/1000m with fan models for operating altitude higher than 2000m(6500ft).</p> <p>8. For any application note and IP water proof function installation caution, please refer our user manual before using. https://www.meanwell.com/Upload/PDF/LED_EN.pdf</p> <p>9. Based on IEC 62386-101/102 DALI power on timing and interruption regulations, the set up time needs to test with a DALI controller which can support for DALI power on function, otherwise the set up time will be higher than 0.5 second for DA type.</p> <p>※ Product Liability Disclaimer : For detailed information, please refer to https://www.meanwell.com/serviceDisclaimer.aspx</p> | | | | |

DIMMING OPERATION

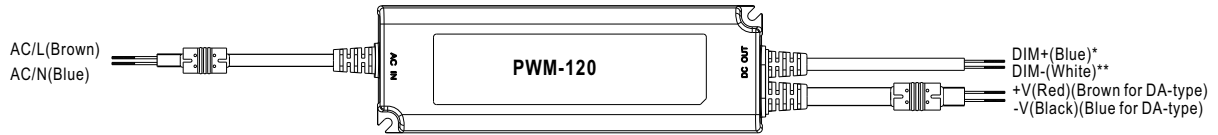

* DIM+ for Blank-Type
 DA+ for DA/DA2-type
 ** DIM- for Blank-Type
 DA- for DA/DA2-type

※ Dimming principle for PWM style output

- Dimming is achieved by varying the duty cycle of the output current.

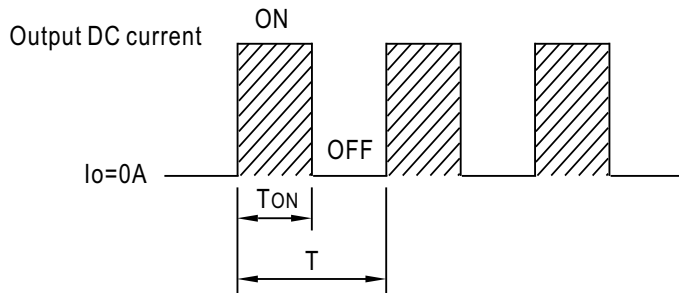

$$\text{Duty cycle(\%)} = \frac{T_{ON}}{T} \times 100\%$$

Output PWM frequency : 1.47kHz for Blank/DA-Type
 2.5kHz for DA2-Type

※ 3 in 1 dimming function (for Blank-Type)

- Apply one of the three methodologies between DIM+ and DIM-: 0 ~ 10VDC, or 10V PWM signal or resistance.
- Dimming source current from power supply: 100µA (typ.)

◎ Applying additive 0 ~ 10VDC

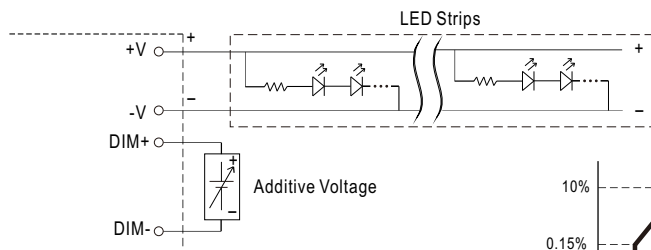

"DO NOT connect "DIM- to -V"

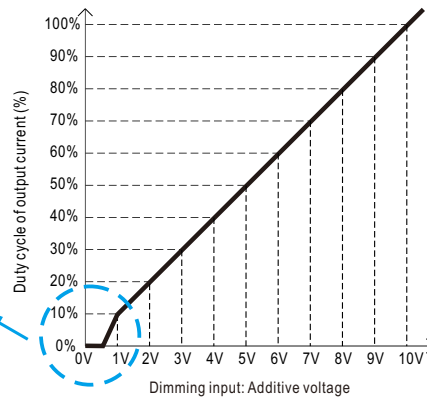
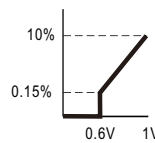

◎ Applying additive 10V PWM signal (frequency range 100Hz ~ 3KHz):

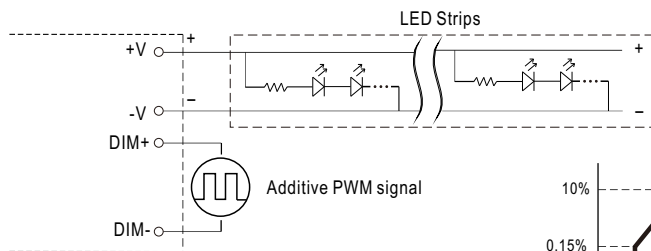

"DO NOT connect "DIM- to -V"

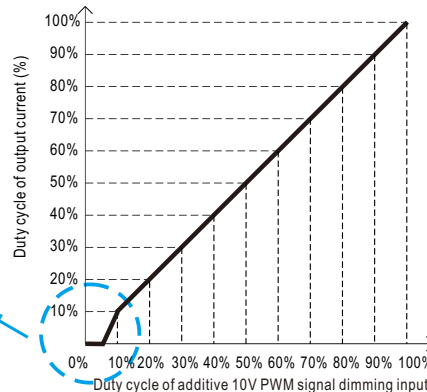
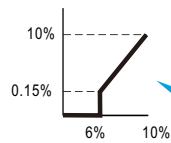

© Applying additive resistance:

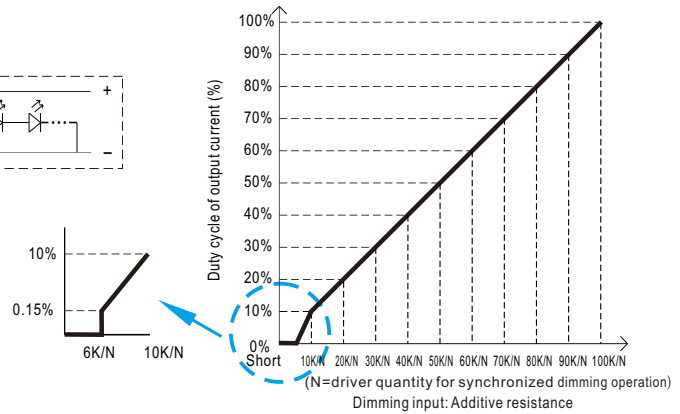
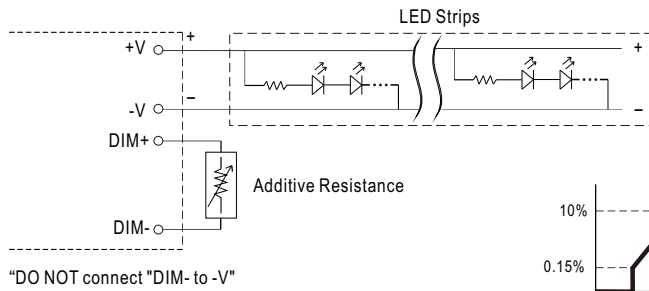

- Note : 1. Min. duty cycle of output current is about 0.15%, and the dimming input is about 6K Ω or 0.6VDC, or 10V PWM signal with 6% duty cycle.
 2. The duty cycle of output current could drop down to 0% when dimming input is less than 6K Ω or less than 0.6VDC, or 10V PWM signal with duty cycle less than 6%.

※ DALI Interface (primary side; for DA/DA2-Type)

- Apply DALI signal between DA+ and DA-.
- DALI protocol comprises 16 groups and 64 addresses.
- First step is fixed at 0.2% of output

OUTPUT LOAD vs TEMPERATURE

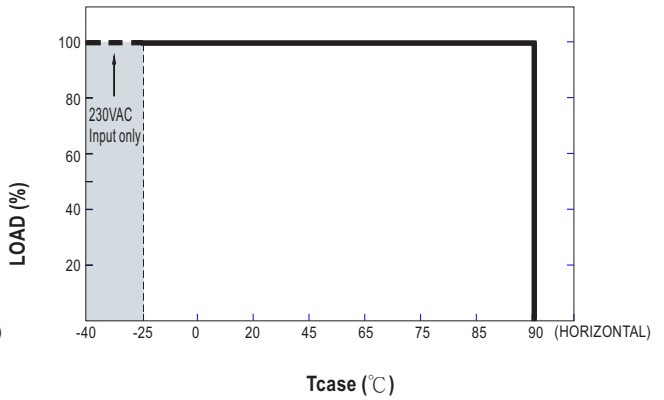
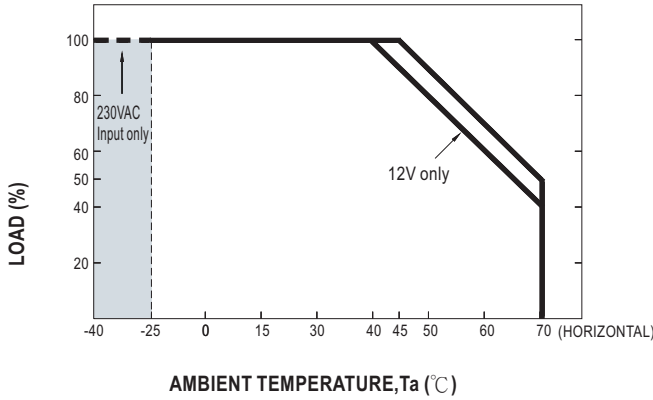

STATIC CHARACTERISTIC

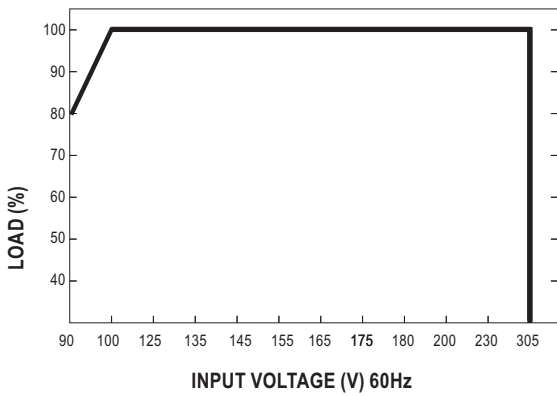

※ De-rating is needed under low input voltage.

POWER FACTOR (PF) CHARACTERISTIC

※ T_{case} at 80°C

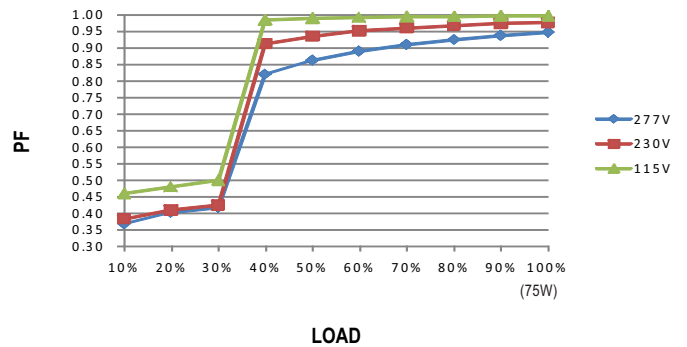

TOTAL HARMONIC DISTORTION (THD)

※ 48V Model, T_{case} at 80°C

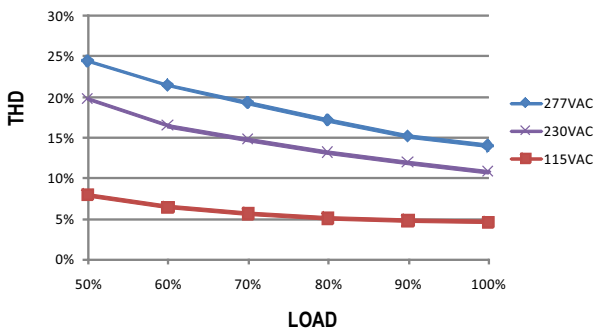

EFFICIENCY vs LOAD

PWM-120 series possess superior working efficiency that up to 90.5% can be reached in field applications.

※ 48V Model, T_{case} at 80°C

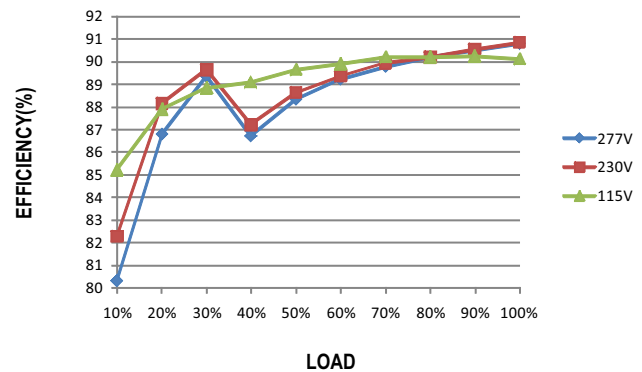

■ LIFE TIME

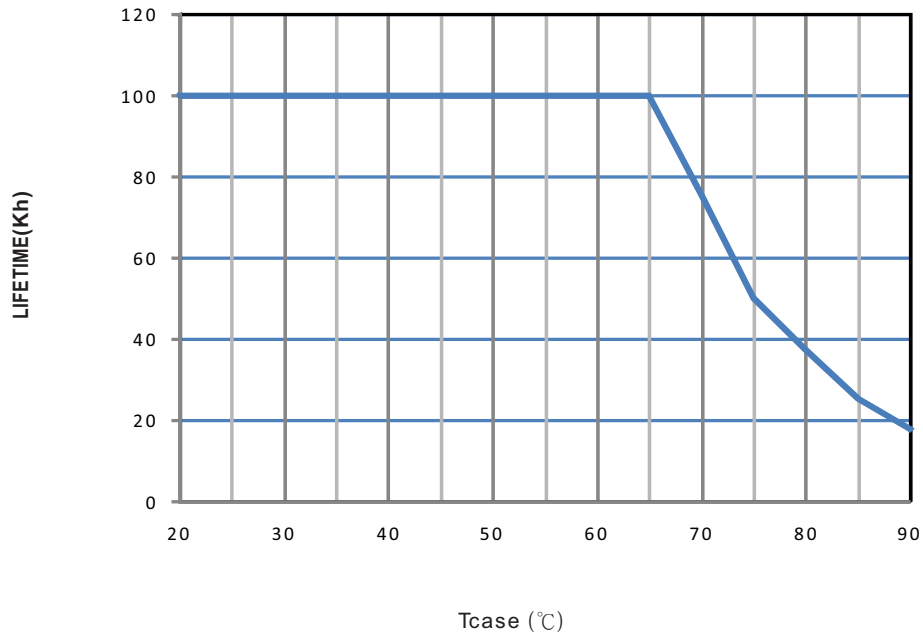

■ Block Diagram

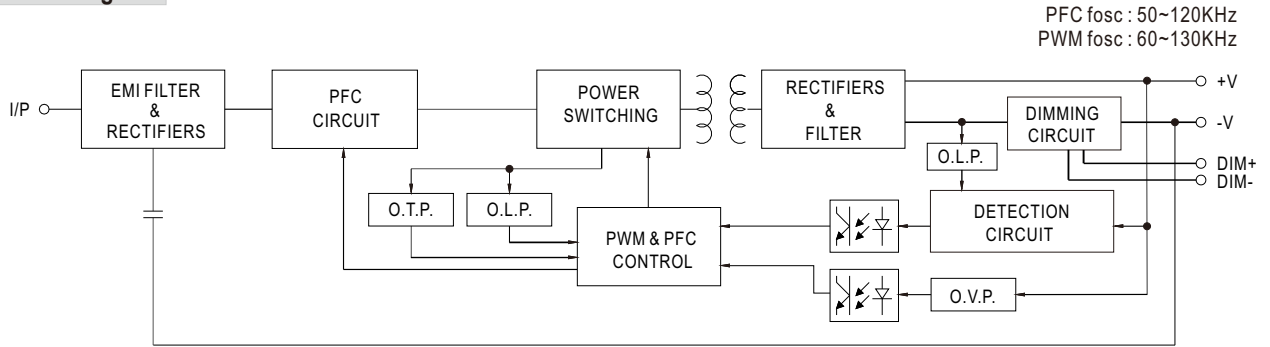

■ Mechanical Specification

Case No. PWM-120 Unit:mm

Blank-Type

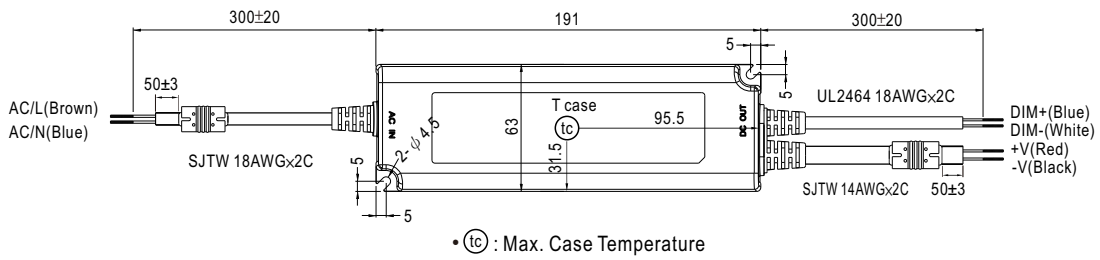

DA/DA2-Type

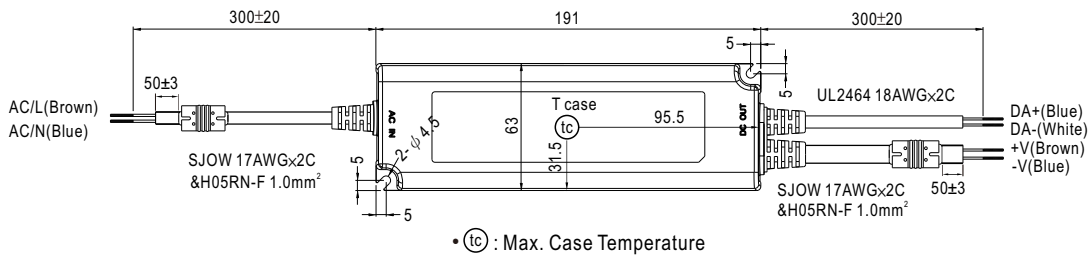

■ Recommend Mounting Direction

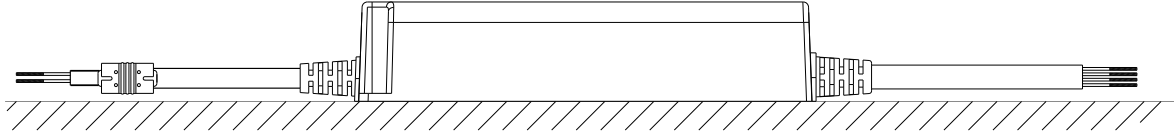

■ Installation Manual

◎ Connection for Blank-type

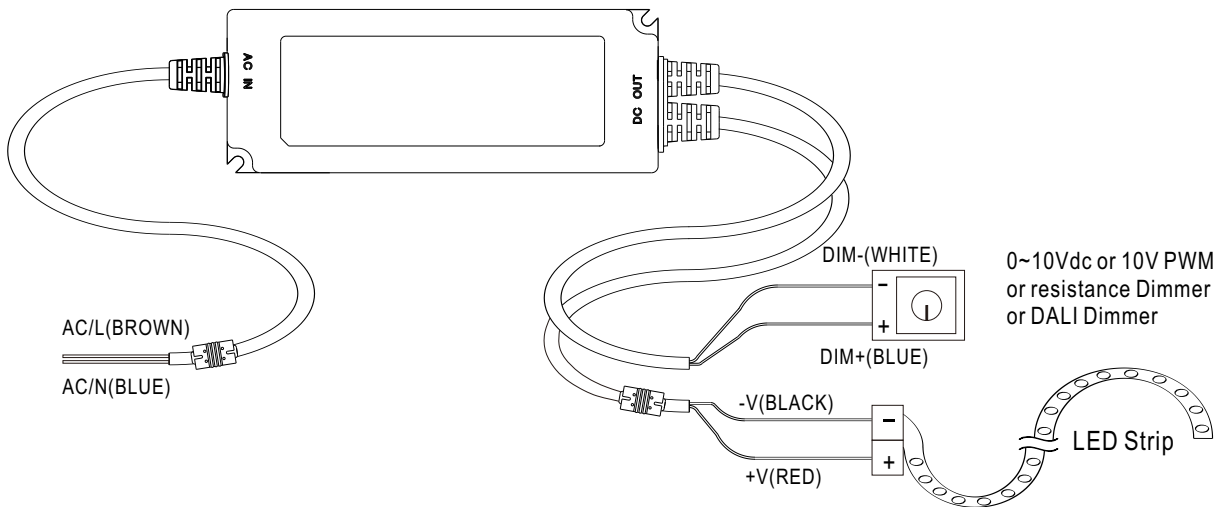

Cautions

- Before commencing any installation or maintenance work, please disconnect the power supply from the utility. Ensure that it cannot be re-connected inadvertently!
- Keep proper ventilation around the unit and do not stack any object on it. Also a 10-15 cm clearance must be kept when the adjacent device is a heat source.
- Mounting orientations other than standard orientation or operate under high ambient temperature may increase the internal component temperature and will require a de-rating in output current.
- Current rating of an approved primary /secondary cable should be greater than or equal to that of the unit. Please refer to its specification.
- For LED drivers with waterproof connectors, verify that the linkage between the unit and the lighting fixture is tight so that water cannot intrude into the system.
- For dimmable LED drivers, make sure that your dimming controller is capable of driving these units. PWM series require 0.15mA each unit.
- Tc max. is identified on the product label. Please make sure that temperature of Tc point will not exceed limit.
- DO NOT connect "DIM- to -V".
- Suitable for indoor use or outdoor use without direct sunlight exposure. Please avoid immerse in the water over 30 minutes.
- The power supply is considered as a component that will be operated in combination with final equipment. Since EMC performance will be affected by the complete installation, the final equipment manufacturers must re-qualify EMC Directive on the complete installation again.